

Technical Product Sheet

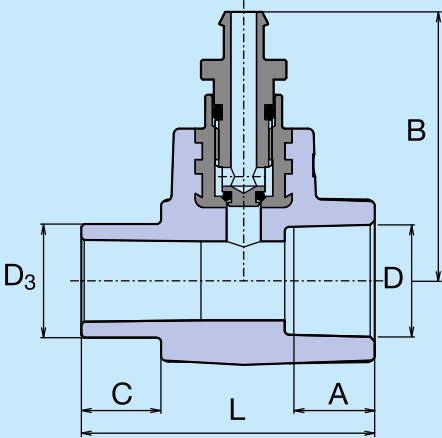

Combined Fittings

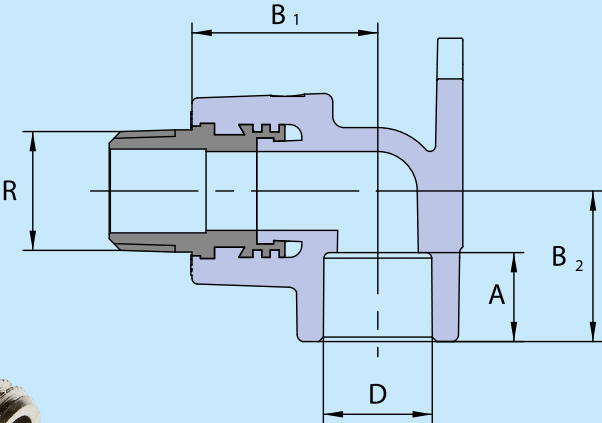

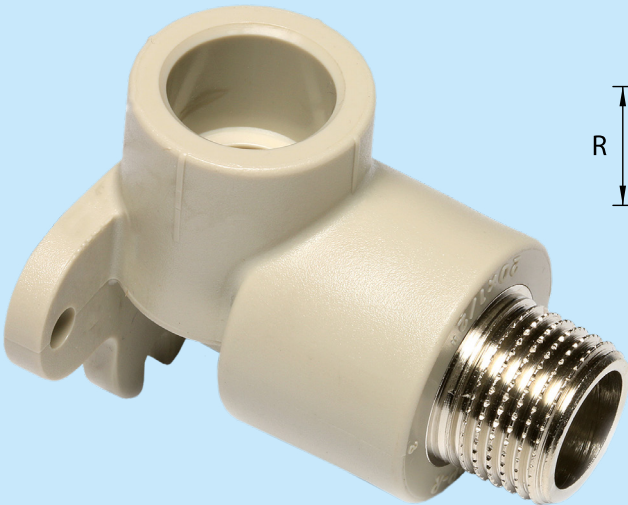
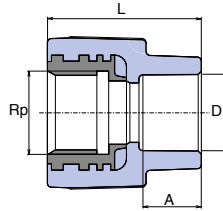

REDUCING SLEEVE WITH METAL FEMALE THREAD

D	Rp	A	L	⊞	⊞	⚖	CODE
mm	mm	mm	mm	I.	II.	kg/pc	
16	1/2"	13,0	38,0	10	50	0,050	SZI01620XX
20	1/2"	14,5	39,0	10	250	0,056	SZI02020XX
20	3/4"	14,5	42,0	10	100	0,072	SZI02025XX
25	1/2"	16,0	40,5	10	50	0,062	SZI02520XX
25	3/4"	16,0	47,0	10	100	0,075	SZI02525XX
32	3/4"	18,0	45,0	10	30	0,081	SZI03225XX
⊕32	1"	18,0	51,0	10	60	0,148	SZI03232OK
⊕40	5/4"	20,5	65,5	5	40	0,260	SZI04040XX
⊕50	6/4"	23,5	66,0	4	20	0,328	SZI05050XX
⊕63	2"	27,5	72,5	2	12	0,616	SZI06363XX
⊕75*	2 1/2"	28	65,5	1	8	0,676	SZI07575RCT
⊕90*	3"	32	90,0	1	6	0,954	SZI09090RCT

⊕ with octagon / * material PP-RCT

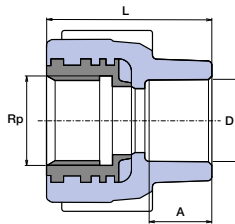

REDUCING SLEEVE WITH METAL FEMALE THREAD WITH CROSS

D	Rp	A	L	⊞	⊞	⚖	CODE
mm	mm	mm	mm	I.	II.	kg/pc	
20	1/2"	14,5	42,0	10	100	0,058	SZI02020KX

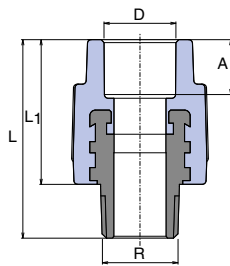

REDUCING SLEEVE WITH METAL MALE THREAD

D	R	A	L	L ₁	⊞	⊞	⚖	CODE
mm	mm	mm	mm	mm	I.	II.	kg/pc	
16	1/2"	13,0	52,0	37,5	10	50	0,064	SZE01620XX
20	1/2"	14,5	53,5	39,0	10	150	0,062	SZE02020XX
20	3/4"	14,5	58,0	40,0	10	100	0,096	SZE02025XX
25	1/2"	16,0	55,5	41,0	10	60	0,066	SZE02520XX
25	3/4"	16,0	59,0	41,0	10	100	0,098	SZE02525XX
32	3/4"	18,0	60,0	44,0	10	30	0,105	SZE03225XX
32	1"	18,0	62,5	46,0	10	60	0,170	SZE03232XX
⊕32	1"	18,0	69,5	42,0	10	60	0,204	SZE03232OK
⊕40	5/4"	20,5	80,0	48,0	5	40	0,312	SZE04040XX
⊕50	6/4"	23,5	81,6	54,0	4	20	0,460	SZE05050XX
⊕63	2"	27,5	101,0	63,5	2	12	0,758	SZE06363XX
⊕75*	2 1/2"	30,0	110,0	69,7	1	8	0,885	SZE07575RCT
⊕90*	3"	33,0	113,5	73,0	1	6	1,228	SZE09090RCT

⊕ with octagon / * material PP-RCT

METAL REDUCER WITH CAP NUT

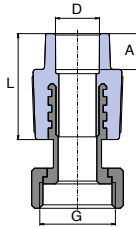

D	G	A	L	⊞	⊞	⚖	CODE
mm		mm	mm	I.	II.	kg/pc	
16	1/2"	13,0	32,0	10	100	0,044	SZM01620XX
16	3/4"	13,0	32,0	10	200	0,082	SZM01625XX
20	1/2"	14,5	40,0	20	100	0,048	SZM02020XX
20	3/4"	14,5	39,0	20	100	0,082	SZM02025XX
20	1"	14,5	39,0	5	40	0,152	SZM02032XX
25	3/4"	16,0	41,1	20	100	0,086	SZM02525XX
25	1"	16,0	41,0	4	40	0,154	SZM02532XX
32	5/4"	18,0	48,0	2	20	0,254	SZM03240XX
⊕ PMD							
20	3/4"	14,5	39,0	10		0,084	SZMD02025X

⊕ PMD – cap nut with the hole for the seal

ELBOW 90 ° WITH METAL FEMALE THREAD

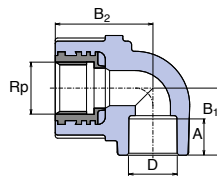

D	Rp	A	B ₁	B ₁	⊞	⊞	⚖	CODE
mm		mm	mm	mm	I.	II.	kg/pc	
16	1/2"	13,0	25,2	31,0	10	50	0,062	SKOI01620X
20	1/2"	14,5	27,0	34,5	10	100	0,062	SKOI02020X
20	3/4"	14,5	27,0	40,0	10	50	0,082	SKOI02025X
25	1/2"	16,0	31,0	36,0	10	50	0,070	SKOI02520E
25	3/4"	16,0	30,0	41,0	10	100	0,090	SKOI02525X
32	1"	18,0	36,0	51,0	10	50	0,168	SKOI03232X

ELBOW 90 ° WITH METAL MALE THREAD

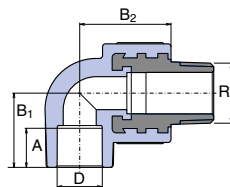

D	Rp	A	B ₁	B ₁	⊞	⊞	⚖	CODE
mm		mm	mm	mm	I.	II.	kg/pc	
16	1/2"	13,0	25,2	31,0	10	50	0,074	SKOE01620X
20	1/2"	14,5	27,0	34,5	10	100	0,074	SKOE02020X
20	3/4"	14,5	27,0	39,0	10	50	0,112	SKOE02025X
25	1/2"	16,0	31,0	36,0	10	50	0,082	SKOE02520E
25	3/4"	16,0	30,0	39,0	10	80	0,116	SKOE02525X
32	1"	18,0	36,0	41,6	5	40	0,118	SKOE03232X

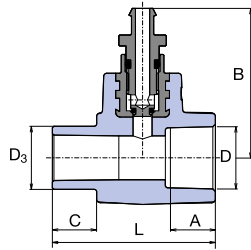

**SOCKET WITH DRAIN VALVE
INTERNAL / EXTERNAL**

D	D ₃	A	L	B	C	⊞	⊞	⚖	CODE
mm	mm	mm	mm	mm	mm	I.	II.	kg/pc	
20	20	14,5	53,0	48,0	13,0	10	100	0,054	SNAV120XX
25	25	16,0	54,0	49,7	14,0	5	150	0,064	SNAV125XX
32	32	18,0	59,0	53,2	16,0	5	100	0,084	SNAV132XX

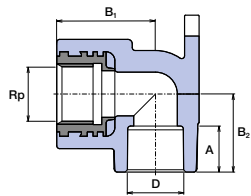

ELBOW 90 ° FOR WALL MOUNTING

D	Rp	A	B ₁	B ₂	⊞	⊞	⚖	CODE
mm		mm	mm	mm	I.	II.	kg/pc	
16	1/2"	13,0	32,0	23,2	10	60	0,064	SNK016XXXX
20	1/2"	14,5	34,0	26,8	10	150	0,068	SNK020XXXX
25	1/2"	16,0	36,0	27,5	10	50	0,072	SNK02520XX
25	3/4"	16,0	39,0	29,5	10	50	0,098	SNK025XXXX

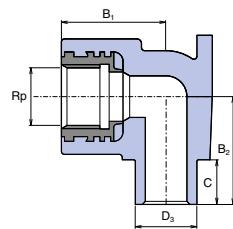

**ELBOW 90 ° FOR WALL MOUNTING
INTERNAL / EXTERNAL**

D ₃	Rp	B ₁	B ₂	C	⊞	⊞	⚖	CODE
mm		mm	mm	mm	I.	II.	kg/pc	
20	1/2"	35,0	35,0	11,0	10	120	0,068	SNK120XXXX

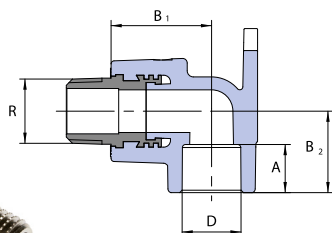

**ELBOW 90 ° FOR WALL MOUNTING
WITH METAL MALE THREAD**

D	R	B ₁	B ₂	A	⊞	⊞	⚖	CODE
mm		mm	mm	mm	I.	II.	kg/pc	
20	1/2"	34,0	32,2	14,5	10	50	0,072	SNKE02020X

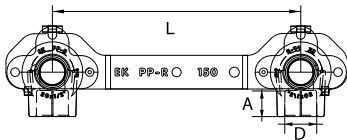
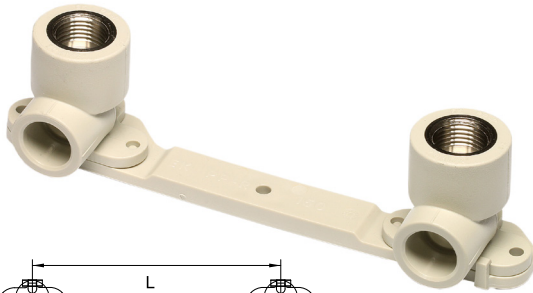

WALL ELBOWS WITH HOLDER

D	A	L	☒	☒	⚖	CODE
mm	mm	mm	I.	II.	kg/pc	
20	14,5	150	10	50	0,162	SNKD02020X

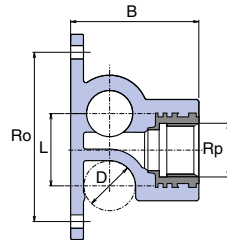

TEE WITH TAP CONNECTOR

D	A	Rp	B	Ro	L	☒	☒	⚖	CODE
mm	mm		mm	mm	mm	I.	II.	kg/pc	
20	14,5	1/2"	50,0	66,0	28,5	20	100	0,080	SNKP020XXX
25	16,0	1/2"	56,0	76,0	33,5	10	50	0,090	SNKP02520X

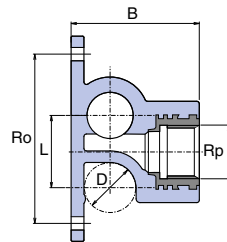

ENDING WALL ELBOW LEFT

D	A	Rp	B	Ro	L	☒	☒	⚖	CODE
mm	mm		mm	mm	mm	I.	II.	kg/pc	
20	14,5	1/2"	50,0	66,0	28,5	5	25	0,066	SNK020KLXX

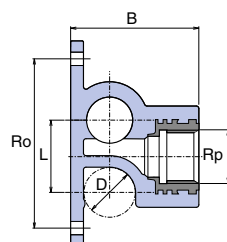

ENDING WALL ELBOW RIGHT

D	A	Rp	B	Ro	L	☒	☒	⚖	CODE
mm	mm		mm	mm	mm	I.	II.	kg/pc	
20	14,5	1/2"	50,0	66,0	28,5	5	25	0,066	SNK020KPXX

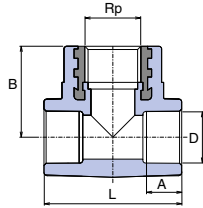

TEE WITH METAL FEMALE THREAD

D	Rp	A	L	B	☒	☒	⚖	CODE
mm		mm	mm	mm	I.	II.	kg/pc	
20	1/2"	14,5	51,5	34,0	10	100	0,068	STKI02020X
25	1/2"	16,0	80,0	40,0	10	100	0,076	STKI02520X
25	3/4"	16,0	80,0	40,0	5	30	0,094	STKI02525X
32	1/2"	18,0	71,0	40,5	5	20	0,106	STKI03220X
32	3/4"	18,0	71,0	42,0	5	25	0,118	STKI03225X
32	1"	18,0	80,0	55,0	5	25	0,186	STKI03232X

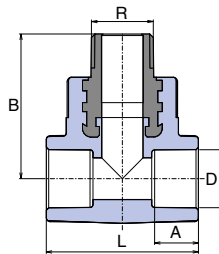

TEE WITH METAL MALE THREAD

D	R	A	L	B	☒	☒	⚖	CODE
mm		mm	mm	mm	I.	II.	kg/pc	
20	1/2"	14,5	51,5	48,5	10	100	0,080	STKE02020X
20	3/4"	14,5	60,0	50,0	5	30	0,118	STKE02025X
25	1/2"	16,0	60,0	51,0	10	80	0,088	STKE02520X
25	3/4"	16,0	65,0	52,5	5	25	0,122	STKE02525X
32	3/4"	18,0	71,0	58,3	5	20	0,146	STKE03225X
32	1"	18,0	80,0	60,0	5	20	0,208	STKE03232X

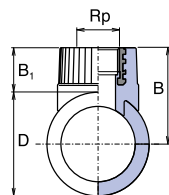

WELD IN SADDLE WITH METAL FEMALE THREAD

D	Rp	B ₁	B	☒	☒	⚖	CODE
mm		mm	mm	I.	II.	kg/pc	
63	3/4"	27,0	58,5	10	50	0,084	SNSI06325X
75	3/4"	27,0	64,5	10	50	0,084	SNSI07525X
90	3/4"	27,0	72,0	10	50	0,084	SNSI09025X

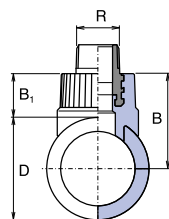

WELD IN SADDLE WITH METAL MALE THREAD

D	R	B ₁	B	☒	☒	⚖	CODE
mm		mm	mm	I.	II.	kg/pc	
63	3/4"	44,8	76,3	10	50	0,112	SNSE06325X
75	3/4"	44,8	82,3	10	50	0,110	SNSE07525X
90	3/4"	44,8	89,8	10	50	0,110	SNSE09025X

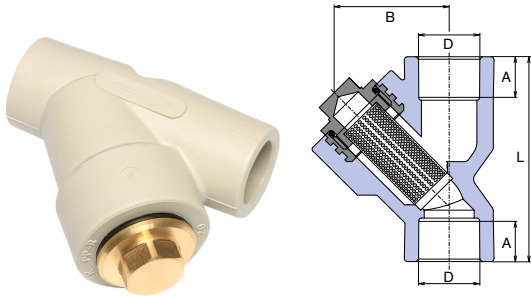

FILTER

D	B	L	A	☒	☒	⚖	CODE
mm	mm	mm	mm	I.	II.	kg/pc	
20	45,0	76,0	14,5	5	40	0,116	SFI020XXXX
25	45,0	82,0	16,0	5	40	0,134	SFI025XXXX
32	55,0	95,0	18,0	5	40	0,234	SFI032XXXX

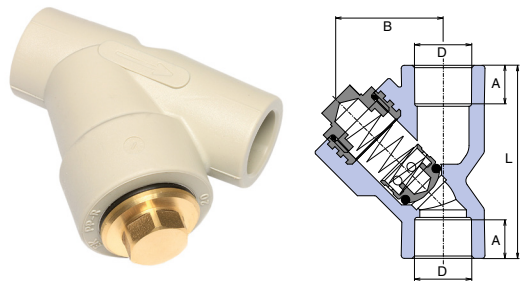

BACK FLOW VALVE

D	B	L	A	☒	☒	⚖	CODE
mm	mm	mm	mm	I.	II.	kg/pc	
20	45,0	76,0	14,5	5	40	0,136	SZKL020XXX
25	45,0	82,0	16,0	5	40	0,154	SZKL025XXX
32	55,0	95,0	18,0	5	40	0,266	SZKL032XXX

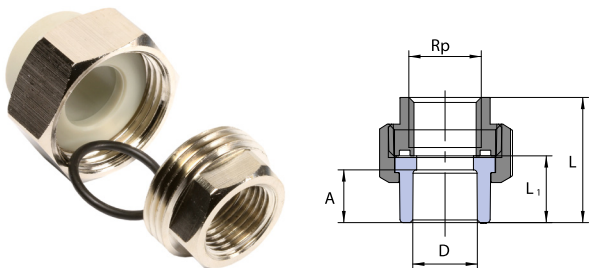

SCREW UNION WITH SOCKET – FEMALE

D	Rp	L	L ₁	☒	☒	⚖	CODE
mm		mm	mm	I.	II.	kg/pc	
20	1/2"	37,5	19,5	10	100	0,122	SSHI02020X
25	3/4"	46,5	23,0	10	70	0,213	SSHI02525X

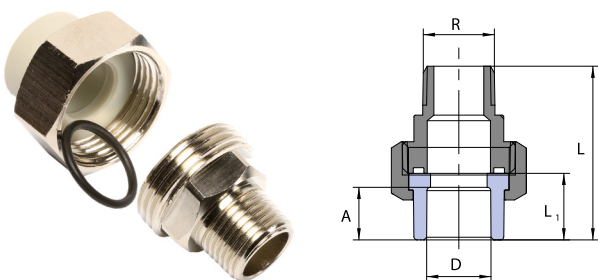

SCREW UNION WITH SOCKET – MALE

D	Rp	L	L ₁	☒	☒	⚖	CODE
mm		mm	mm	I.	II.	kg/pc	
20	1/2"	52,5	19,5	10	100	0,142	SSHE02020X
25	3/4"	59,0	23,0	10	50	0,223	SSHE02525X

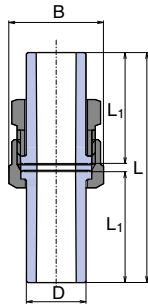

COUPLING WITH NUT

D	B	L	L ₁	⊞	⊞	⚖	CODE
mm	mm	mm	mm	I.	II.	kg/pc	
20	30,0	82,0	40,0	20	100	0,088	SRS020XXXX
25	38,0	82,0	40,0	20	100	0,142	SRS025XXXX
32	46,0	92,0	45,0	10	50	0,212	SRS032XXXX
40	58,0	112,0	55,0	5	30	0,288	SRS040XXXX

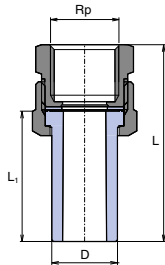

SCREW UNION - FEMALE

D	Rp	L	L ₁	⊞	⊞	⚖	CODE
mm		mm	mm	I.	II.	kg/pc	
20	1/2"	60,0	40,0	10	100	0,086	SSI02020XX
25	3/4"	62,0	40,0	10	70	0,136	SSI02525XX
32	1"	70,0	45,0	10	50	0,220	SSI03232XX

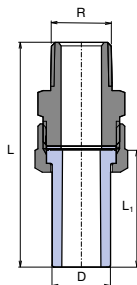

SCREW UNION - MALE

D	R	L	L ₁	⊞	⊞	⚖	CODE
mm		mm	mm	I.	II.	kg/pc	
20	1/2"	77,0	40,0	10	100	0,118	SSE02020XX
25	3/4"	80,0	40,0	10	50	0,196	SSE02525XX
32	1"	92,0	45,0	10	40	0,324	SSE03232XX

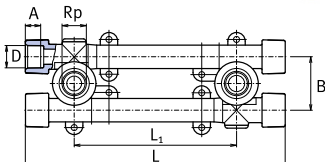

WALL MOUNTING GROUP WITH TAP CONNECTORS

D	Rp	A	B	⊙ L ₁	L	⊞	⊞	⚖	CODE
mm		mm	mm	mm	mm	I.	II.	kg/pc	
20	1/2"	14,5	46,0	105/130/145	229,0	1	10	0,220	SNKK020XXX
25	1/2"	16,0	51,0	110/125/140	230,0	1	10	0,268	SNKK025XXX

⊙ L₁ – extension 100, 135, 150 mm, it is necessary to set right with eccentric parts.

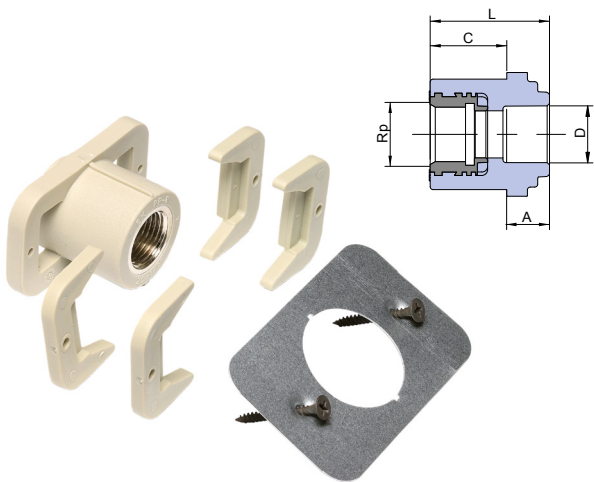

REDUCING SLEEVE FOR GYPSUM WALL MOUNTING

D	Rp	A	C	L	☒	☒	⚖	CODE
mm		mm	mm	mm	I.	II.	kg/pc	
20	1/2"	14,5	26,0	40,5	1	10	0,102	SZS02020X

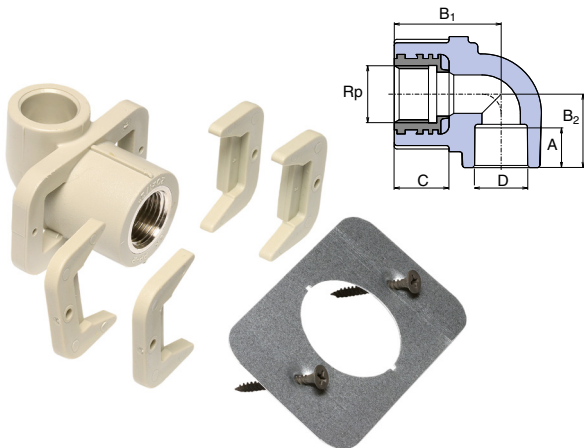

FOR GYPSUM WALL MOUNTING

B	Rp	A	B ₁	B ₂	C	☒	☒	⚖	CODE
mm		mm	mm	mm	mm	I.	II.	kg/pc	
20	1/2"	15	44,0	27,0	26,0	1	10	0,114	SNKS020SX

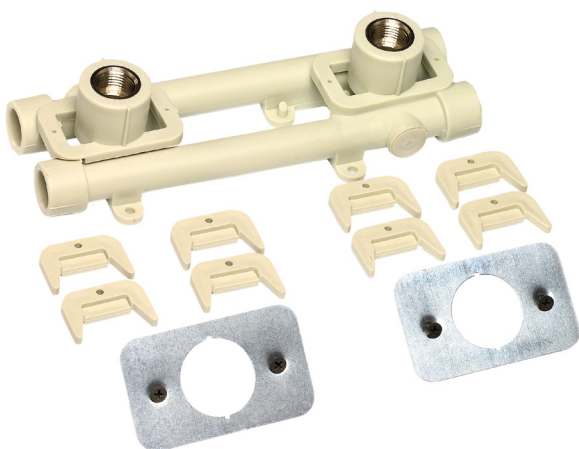

WALL MOUNTING GROUP WITH TAP CONNECTORS FOR GYPSUM WALL

D	Rp	A	B	L ₁	C	L	☒	☒	⚖	CODE
mm		mm	mm	mm	mm	mm	I.	II.	kg/pc	
20	1/2"	14,5	49,0	100/135/150	26,0	234,0	1	10	0,320	SNKK020SXX

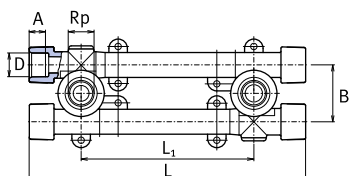

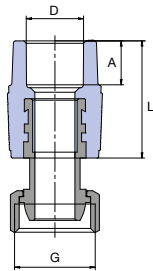

METAL REDUCER CAP NUT – EUROKONUS

D	G	A	L	☞	☞	⚖	CODE
mm		mm	mm	I.	II.	kg/pc	
20	3/4"	14,5	40,0	5	25	0,089	SZM02025EX

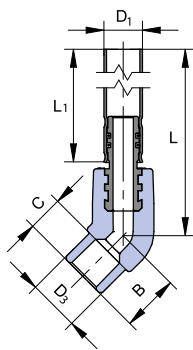

RADIATOR CONNECTOR ELBOW 45 °

D ₁	D ₃	B	C	L	L ₁	☞	☞	⚖	CODE
mm	mm	mm	mm	mm	mm	I.	II.	kg/pc	
15	20	22,5	13	298	270	1	20	0,123	SKORP12045270
15	20	22,5	13	748	720	1	20	0,270	SKORP12045720

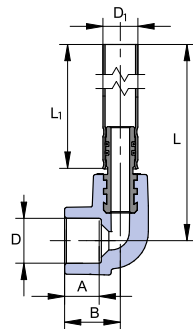

RADIATOR CONNECTOR ELBOW 90 °

D	D ₁	A	B	L	L ₁	☞	☞	⚖	CODE
mm	mm	mm	mm	mm	mm	I.	II.	kg/pc	
20	15	14,5	24	300	270	1	20	0,126	SKORP02090270
20	15	14,5	24	750	720	1	10	0,273	SKORP02090720

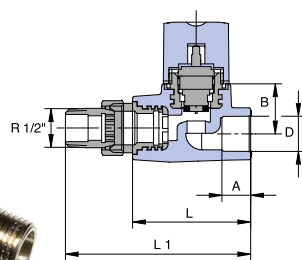

RADIATOR VALVE STRAIGH WITH THERMOSTAT

D	A	B	L	L ₁	R	☞	☞	⚖	CODE
mm	mm	mm	mm	mm		I.	II.	kg/pc	
20	14,5	24,5	65	102	1/2"	1	20	0,265	SVER020PXX

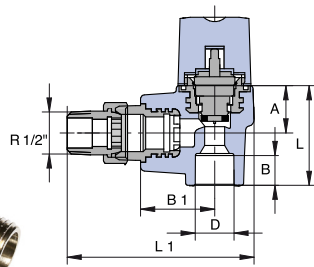

RADIATOR VALVE ANGLE WITH THERMOSTAT

D	A	B	B ₁	L	L ₁	R	☐	☐	⚖	CODE
mm	mm	mm	mm	mm	mm		I.	II.	kg/pc	
20	14,5	23,5	36,5	49,5	93	1/2"	1	20	0,269	SVER020RXX

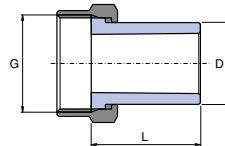

UNION PLASTIC / BRASS UNWELDED

D	G	L	☐	☐	⚖	CODE
mm		mm	I.	II.	kg/pc	
20	3/4"	40,0	10	100	0,048	SHM02025XX
25	1"	40,0	10	50	0,074	SHM02532XX
32	5/4"	45,0	5	100	0,096	SHM03240XX

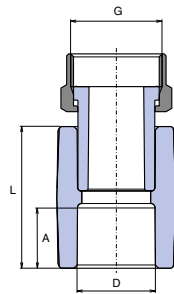

PLASTIC REDUCING SLEEVE WITH CAP NUT

D	G	A	L	☐	☐	⚖	CODE
mm		mm	mm	I.	II.	kg/pc	
16	1/2"	13,0	33,0	10	200	0,032	SNAM01620X
20	1/2"	14,5	34,6	50	200	0,034	SNAM02020X
20	3/4"	14,5	34,6	25	200	0,056	SNAM02025X
25	3/4"	16,0	37,8	20	100	0,058	SNAM02525X
25	1"	16,0	37,8	10	50	0,092	SNAM02532X
32	1"	18,0	40,0	10	50	0,102	SNAM03232X
PMD							
20	3/4"	14,5	34,6	10	50	0,056	SNAMD02025
25	3/4"	16,0	37,8	10	50	0,062	SNAMD02525

PMD – cap nut with the hole for the seal

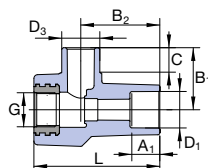

FLOWMETER BODY

D ₁	D ₂	☐	☐	⚖	CODE
mm	mm	I.	II.	kg/pc	
16	32	5	20	0,103	SROZ132163RCT
20	32	5	20	0,097	SROZ132203RCT

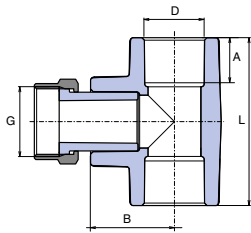

TEE PLASTIC REDUCING SLEEVE WITH CAP NUT

D	G	A	B	L	☒	☒	⚖	CODE
mm		mm	mm	mm	I.	II.	kg/pc	
20	3/4"	14,5	54,0	27,0	10	60	0,069	STKM02025X
25	3/4"	16,0	60,0	32,0	5	50	0,079	STKM02525X
25	1"	16,0	60,0	32,0	5	30	0,157	STKM02532X
32	3/4"	18,0	70,0	35,7	5	50	0,100	STKM03225X
32	1"	18,0	70,0	35,7	5	50	0,135	STKM03232X

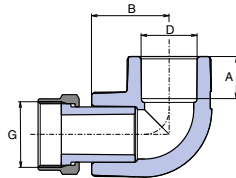

ELBOW 90 ° PLASTIC REDUCING SLEEVE WITH CAP NUT

D	G	A	B	☒	☒	⚖	CODE
mm		mm	mm	I.	II.	kg/pc	
20	1/2"	14,5	26,8	25	100	0,047	SKOM02020X
20	3/4"	14,5	26,8	25	100	0,062	SKOM02025X

Product Range – Basic Information

Fittings are manufactured for all piping types in the highest PN 20 pressure range and in various configurations.

- ⦿ Combined fittings with brass, nickel-coated threads for threaded joints (reducing sleeves with metal thread, T-pieces, elbows for wall mounting, wall mounting groups with tap connectors, plastic reducing sleeves with cap nut)
- ⦿ Combined fittings for flanged joints
- ⦿ Special fittings for heating (eurokonus, radiator connector)

Fittings of the Ekoplastik System are produced in the following sizes 16, 20, 25, 32, 40, 50, 63, 75, 90 mm.

Each class of application refers to a typical field of use and for a period of 50 years. Each class of application must be associated with the pressure it is designed for (operating system pressure). This information is assigned to each pipe in the following format: class of application/pressure, for example 1/10 bar. It means the pipe is categorized as class 1 and has the maximum operating pressure of 10 bar.

The classes of application according to ISO 10508:

- ⦿ **class 1** (supply of hot water of 60 °C, service life 50 years)
- ⦿ **class 2** (supply of hot water of 70 °C, service life 50 years)
- ⦿ **class 4** (floor heating, low temperature heaters, service life 50 years, assuming (in total for the entire lifetime) 2.5 years at the operating temperature of 20 °C, 20 years at the operating temperature of 40 °C, 25 years at the operating temperature of 60 °C, 2.5 years at the operating temperature of 70 °C)
- ⦿ **class 5** (high temperature heaters, service life 50 years, out of which (in total for the entire length of service life) 14 years at the operating temperature of 20 °C, 25 years at the operating temperature of 60 °C, 10 years at the operating temperature of 80 °C, 1 year at the operating temperature 90 °C). Maximum operating pressure (4, 6, 8, 10 bar) corresponding to the application class is calculated and assigned for each material and pipe series S.

All fittings are universal and suitable for all types and pressure lines of Ekoplastik pipes. The operating parameters are specified in the Installation Manual.

Specification of raw material used in production and Properties of Ekoplastik System

Fittings of Ekoplastik System in diameter 16-63 mm are manufactured from polypropylene Type 3. Fittings in diameter 75-90 mm are manufactured from polypropylene Type 4, PP-RCT.

Selected characteristics of pipes

characteristics		units	PPR value
specific gravity	PPR, PP-RCT	g / cm ³	0,9
thermal conductivity coefficient	all types of pipes	W / m °C	0,24

Advantages

- ⌚ Service life of more than 50 years (subject to proper utilisation)
- ⌚ No health risks
- ⌚ No corrosion or encrustation
- ⌚ Flexibility, low weight, easy and clean installation
- ⌚ Low-noise level, low pressure losses due to friction
- ⌚ Environmentally friendly product (can be recycled or safely incinerated)

Isothermal lines for PPR mechanical strength

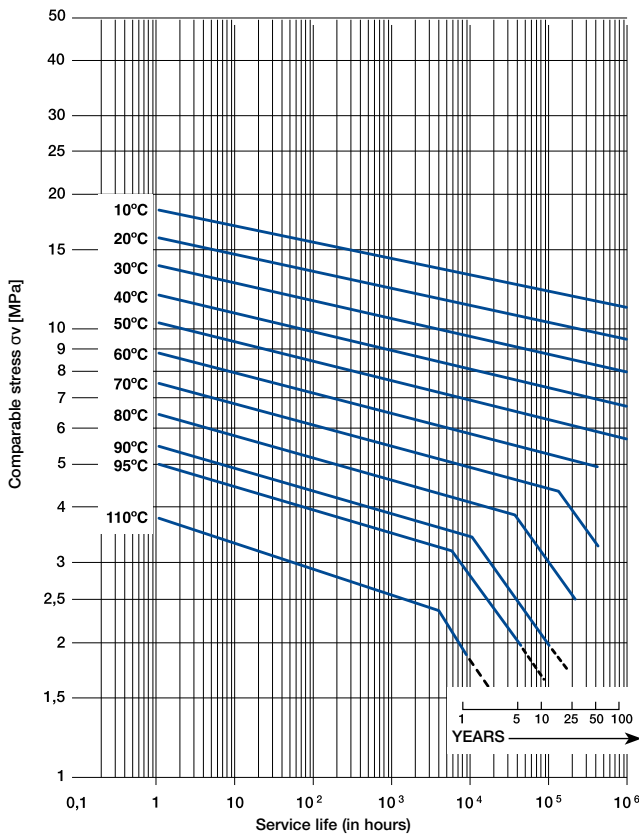

Isothermal lines for PP-RCT mechanical strength

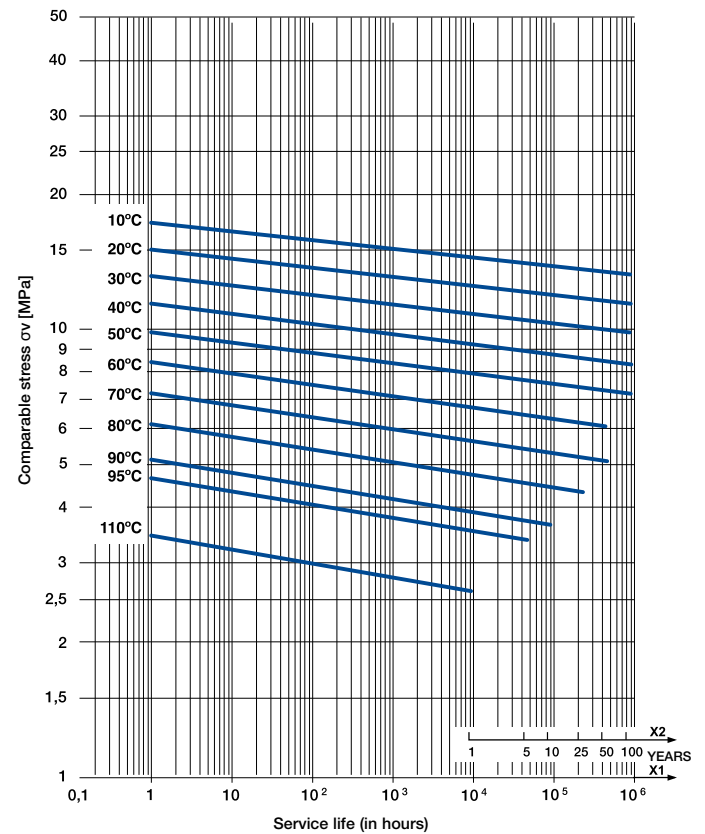

Termination of the isotherm indicates maximum service life even at lower tensions. The isotherms depicted in the chart are not extended.

Product manufacturing and testing standards

Ekoplastik System products are manufactured according to internal company standard PN 01 corresponding to EN ISO 15874 and German standards DIN 8077 and DIN 8078, DIN 16962, DIN 4726. The internal company standards are continuously being updated with further specification guidelines taken from the newly introduced European (EN) System of Standards.

In order to meet quality requirements specified in ISO 9001, the following activities are regularly controlled within the framework of specified procedures.

Controlled:

- ① characteristics of raw materials entering the manufacturing process
- ① intermediate product parameters at every production stage
- ① manufacturing facilities
- ① parameters of measuring instruments

Warranty

All standard products of the Ekoplastik System are covered by a 10-year warranty period. This guarantee is subject to a proper product application and adherence to the Installation Manual.

Service life

Service life of more than 50 years (subject to proper utilisation).

